

WEDISON

Motor Listrik Yang Paling Super Nge-Chargenya!



Athena

USER MANUAL

www.wedison.co

WEDISON USER MANUAL

Table of Content

Wedison User Manual - English		
1	Intro	1
2	Safety Instructions	2
3	Component Overview	4
4	Indicator Codes	9
5	Riding Modes	10
6	Operating Guide	11
7	Riding Instructions	14
8	Charging Guide (Regular & Super Charging)	15
9	Maintenance & Service Schedule	19
10	Warranty & Claim Terms	20
11	FAQ & Troubleshooting	21
Buku Panduan Pengguna Wedison - Bahasa Indonesia		
12	Pendahuluan	25
13	Petunjuk Keselamatan	26
14	Gambaran Umum Komponen	28
15	Indikator Panel	33
16	Mode Berkendara	34
17	Panduan Pengoperasian	35
18	Instruksi Berkendara	38
19	Pengisian Daya (Regular & Super Charge)	39
20	Perawatan & Jadwal Servis	43
21	Syarat Garansi & Klaim	44
22	FAQ & Pemecahan Masalah	45

WEDISON USER MANUAL

Congratulations on owning the **Wedison Athena**, a classic sporty style electric motorcycle powered by modern technology. With its timeless design combined with reliable performance, Athena offers a unique riding experience that blends style, comfort, and the future of mobility.

This manual provides essential information on the proper operation, maintenance, and safety of your EdPower.

Please read it carefully before riding to ensure the best performance and long-term reliability of your motorcycle.

Our Best Regards,



SAFETY INSTRUCTION RIDER & RIDING SAFETY

A. Before Riding, please make sure to:

- Always wear an **SNI-Certified** helmet and protective gear when riding.
- Check the vehicle's condition before each ride: brakes, lights, tires, and battery indicator.
- Ensure the battery is securely installed and the cover is properly locked.
- **Do not** ride when feeling tired, ill, or under the influence of alcohol or drugs.

B. While Riding, please make sure to:

- Always obey traffic laws and road signs.
- **Do not** exceed speed limits or perform dangerous maneuvers.
- Maintain a safe following distance of at least 3 seconds from the vehicle ahead.
- Avoid sudden acceleration or hard braking, especially on slippery roads.
- **Do not** use mobile phones, gadgets, or headphones while riding.
- Always turn on the headlight in rainy, foggy, or nighttime conditions.
- Avoid riding through flooded roads deeper than 10 cm, as it may damage electrical components.
- **Do not** carry more passengers than allowed.
- **Do not** modify the suspension, braking system, or electrical system without Wedison's authorization.

C. Road & Environmental Conditions

- Avoid severely damaged, rocky, or uneven roads that may endanger the rider or vehicle.
- **Do not** ride in poorly ventilated areas (underground parking) for long periods.
- Be cautious on steep slopes, do not attempt if inexperienced.
- Stop riding immediately in extreme weather (heavy rain, strong winds, thick fog).

D. Interaction with Other Vehicles

- Use the horn moderately, only when necessary.
- Always signal with indicators or hand gestures before turning.
- **Do not** overtake from the left unless it is safe and legal to do so.
- Keep a safe distance from large vehicles (buses, trucks) to avoid blind spots.

E. Night Riding Precautions

- Use low-beam headlights to avoid dazzling other drivers.
- Wear clothing with reflective strips or bright colors.
- Check that front lights, tail lights, and turn signals are functioning properly.

SAFETY INSTRUCTION

BATTERY & CHARGING SAFETY

A. General Battery Safety

- Use only original **Wedison-certified batteries**.
- **Do not** disassemble, modify, or attempt to repair the battery yourself.
- Keep the battery away from fire, water, and direct sunlight.
- **Do not** expose the battery to temperatures above 45°C or below 0°C.
- If the battery casing is deformed, leaking, or producing unusual odors, stop using it immediately.

B. Charging Precautions

- Always use the official Wedison charger provided with the vehicle.
- Charge the battery in a dry, well-ventilated area away from flammable materials.
- **Do not** charge in bathrooms, kitchens, or near combustible objects.
- Ensure the charging port is clean and dry before connecting the charger.
- **Do not** cover the charger or battery during charging, allow proper air circulation.
- Avoid frequent full discharges; charge when the battery level reaches around 20–30%.
- Unplug the charger immediately after the battery is fully charged.

C. Road & Environmental Conditions

- Keep children and pets away from the charging area.

- **Do not** move the vehicle or attempt to ride while charging.
- If you notice abnormal heat, smoke, or smell, disconnect the charger immediately and contact Wedison service.
- **Do not** charge the battery outdoors in heavy rain, snow, or extremely humid conditions.

D. Safety Warning

- If the vehicle is not used for more than one week, charge the battery at least once a month and store it at its optimal capacity.
- Always use and store the battery in the recommended environment to maintain its normal lifespan.
- During regular use, charge the battery in a timely manner, ideally when the battery level falls to around 20%, to extend battery life.
- **Do not** charge the battery in environments below 0°C.
- Use only compliant, approved chargers. Using non-compliant chargers may cause battery leakage, overheating, smoking, fire, or explosion.
- **High Voltage - Do Not Disassemble.** Unauthorized disassembly may result in electric shock, leakage, overheating, fire, explosion, or other serious hazards.
- **Do not** pierce, drop, or apply strong pressure to the battery. Avoid contact with sharp objects to prevent damage, leakage, overheating, fire, or explosion.
- Charge only in a well-ventilated area with adequate heat dissipation. **Do not** charge the battery in enclosed indoor spaces.



COMPONENT OVERVIEW FRONT SECTION



1. Side Mirror
2. Handle Bar
3. Brake
4. Front Headlights
5. Front Sign Lights



COMPONENT OVERVIEW SIDE SECTION



1. Super Charge Port
2. Seat
3. Rear Tail Lights
4. Side Reflector
5. Dual Shock Absorber
6. Electrical Engine
7. Rear Tire
8. Main Stand
9. Side Stand
10. Front Tire
11. Front Disc Brake



COMPONENT OVERVIEW REAR SECTION



1. Key Activation Hole
2. USB Port
3. Rear Disc Brake
4. Rear Reflector
5. Rear Sign Lights



COMPONENT OVERVIEW

LED DISPLAY SPEEDOMETER SECTION



READY

Mode Indicator

0.0 km/h

Speed Indicator

ECO

ECO Mode Indicator

Normal

Normal Mode Indicator



Battery Level

0.0 KM

Total Trip Distance



COMPONENT OVERVIEW HANDLE BAR INSTRUMENT SECTION

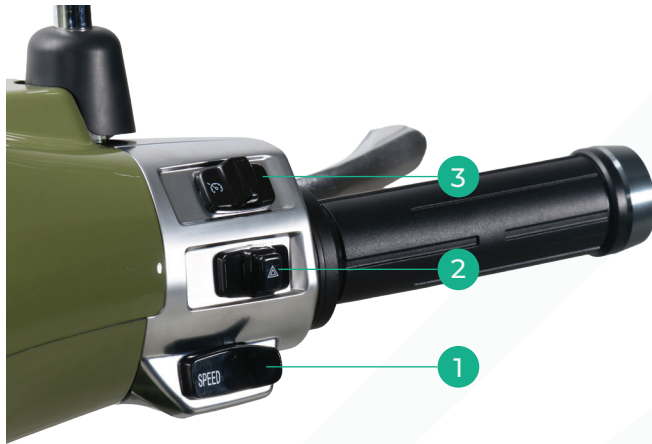

Right Handle Bar

1. Gear Shifting Button
2. Hazard Lights Button
3. Headlights Toggle

Left Handle Bar

4. Headlights Beam Level
5. Turning Sign Lights Toggle
6. Horn Button

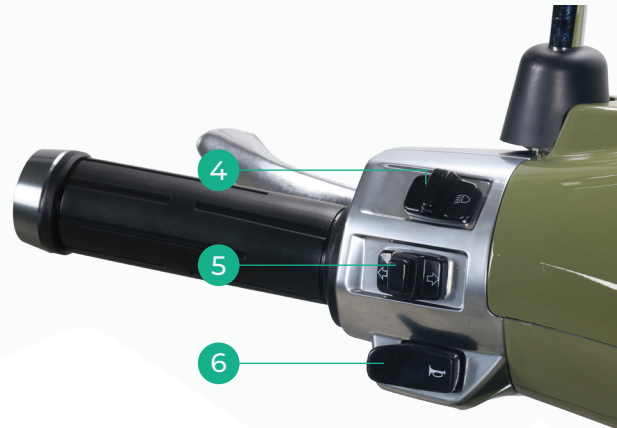

INDICATOR CODES

READY

Mode Indicator

Indicate the mode you're on.

0.0_{km/h}

Speed Indicator

Displaying the speed level you are on.

GEAR

Gear-Level Indicator

Displaying the gear level you are on.

0.0_{km}

Total Trip Distance

Displaying the amount of your Total Trip Distance.



Battery Level

Displaying Battery Level of your motorcycle.



Mode Indicator

Displaying the Mode you are on.



Headlight Beam Level

Indicate the Headlight Beam Level mode that you are on.



Charging Status

Displayed when the vehicle is on charging.



Braking Indicator

Displayed on when you are using the brakes at the moment.



ECU Part Warning

Displayed to inform the rider that ECU part is damaged or need to be repaired.



Damaged Engine
Warning

Displayed to inform the rider that engine part is damaged or need to be repaired.



The Wedison Athena is equipped with a conventional-style two-gear transmission system, combined with a Neutral (Parking Mode) position. This allows the rider to adapt performance to different road conditions while maintaining smooth control, similar to traditional motorcycles.

A. Gear-Levels

- Gear 1:
 - Use for starting from standstill, climbing slopes, or riding in congested traffic.
 - Provides smoother throttle response at lower speed.
- Gear 2:
 - Use for cruising and higher-speed riding.
 - Offers stronger acceleration and improved efficiency on open roads.
- Parking Mode (P):
 - Use when parking or when the motorcycle is stationary.
 - Power is not transmitted to the wheel.

B. Gear-Shifting Instruction

- Always maintain a steady throttle when shifting gears.
- Upshift to **Gear 2** once the vehicle reaches medium speed or when more power is needed.
- Downshift to **Gear 1** when slowing down, climbing, or requiring more control.
- Switch to Neutral only when the vehicle is fully stopped.

C. Safety Precautions

- Do not apply sudden throttle during gear changes.
- Always confirm the gear indicator on the dashboard before accelerating.
- Switch to Neutral before parking or leaving the motorcycle unattended.

D. Dashboard Indicator Awareness

- Always check the gear indicator on the instrument panel before accelerating.
- Make sure "P" (**Parking Mode**) is displayed when parking the motorcycle or turning it on without the intention to ride.
- Do not ignore warning lights or error indicators while operating the gears.

OPERATING GUIDE

PRE-START

This section explains the basic operation of the Wedison Athena, from starting the motorcycle to normal riding and parking. Always follow the steps carefully to ensure safe use.

Pre-Start

1. Insert Key to the ignition switch
2. and turn the key to “” position until it triggers the seat clicks.
3. Lift the Seat
4. Turn the toggle on the *Circuit Breaker* under the seat to “ON” side.

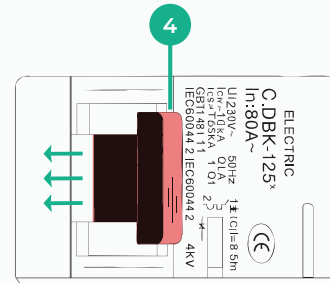
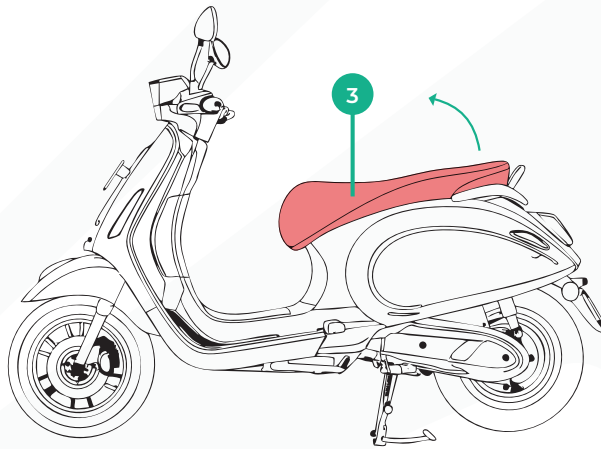
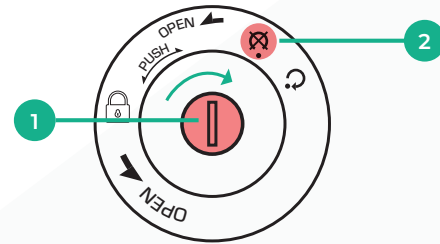

OPERATING GUIDE ENGINE START

Engine Start Procedures:

1. Insert the key into the ignition switch and turn it to the “⌚” position.
2. Ensure the side stand is folded and the motorcycle is upright.
3. Check the dashboard indicators for battery level, gear/mode, and warning lights.
4. Press and hold either brake lever until “P” mode is set off.
5. Confirm that the Normal indicator is illuminated. Then, Select the desired gear (Gear 1 for start).
6. Gently twist the throttle to begin moving forward.

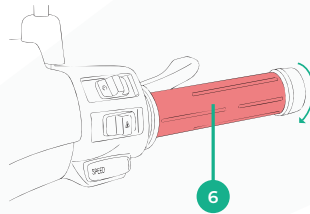
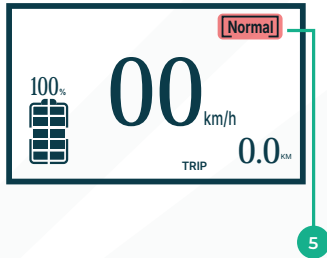
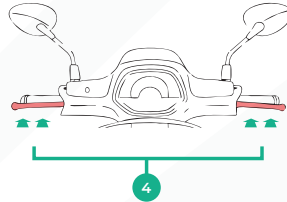
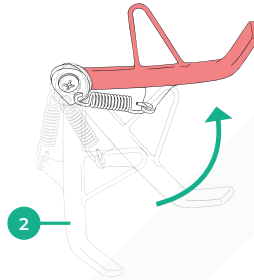
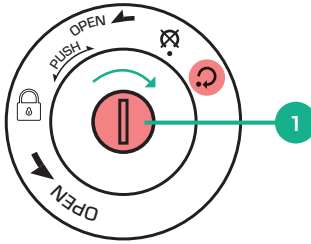

OPERATING GUIDE

A. Important Notes ⚠️

1. The motorcycle **will not** operate if the side stand is engaged.
2. Always verify the gear indicator **before** twisting the throttle.
3. **Do not** apply sudden throttle immediately after starting to avoid unintended movement.
4. If any warning light remains on, **do not** ride. Contact an authorized Wedison Service Center.



A. Before Riding

- Check tire pressure, brakes, lights, horn, and mirrors.
- Verify the battery level is sufficient for the planned trip.
- Ensure the side stand is folded and the motorcycle is upright.
- Confirm the gear indicator is set to **Gear 1** before moving off.

B. Starting to Ride

- Hold one of the brake levers.
- Gently twist the throttle to accelerate smoothly.
- Keep both hands on the handlebars and both feet on the footrests.
- Release the brake gradually while increasing throttle to move forward.

C. Riding at Low and Medium Speed

- Use **Gear 1** for slow riding, congested traffic, or climbing slopes.
- Shift to **Gear 2** when the motorcycle reaches a stable speed for cruising.
- Maintain a safe distance from other vehicles.

D. Braking

- Close the throttle gradually.
- Apply both front and rear brakes evenly.
- Avoid sudden or hard braking to prevent skidding.

- **Downshift to Gear 1** if slowing down significantly or approaching a stop.

E. Stopping

- Bring the motorcycle to a complete stop using both brakes.
- Shift the gear selector to **Neutral/Parking Mode (P)**.
- Keep holding the brake until the motorcycle is stable.

F. Safety Precautions ⚠

- **Do not** accelerate abruptly.
- **Always** signal before turning or changing lanes.
- **Reduce speed** when riding on wet, sandy, or uneven roads.
- **Do not** carry more passengers than specified in the vehicle's capacity.
- **Avoid** distractions such as using mobile phones while riding.

CHARGING GUIDE

REGULAR CHARGE (HOME CHARGING)

This section explains how to safely charge the Wedison Athena battery using the standard charging method. Always follow the steps in sequence to ensure safe and efficient charging.

Preparation Before Charging

- Park the motorcycle on a flat, stable surface.
- Switch the ignition to OFF and confirm the gear is set to Neutral/Parking Mode (P).
- Ensure the side stand or center stand is properly engaged.
- Use only the official Wedison charger supplied with the vehicle.
- Check that the charging port and cable are clean, dry, and free of damage.

A. Charging Procedure

1. Open the charging port cover under the seat.
2. Insert the charger connector firmly into the motorcycle's charging port.
3. Plug the charger into a standard AC power outlet.
4. Confirm that the charging indicator light is illuminated.
5. When charging is complete, unplug the AC power cord first, then disconnect the charger from the motorcycle.
6. Close the charging port cover securely.

Light Indicator :

- **Red** = Charging in Progress
- **Green** = Charging Completed

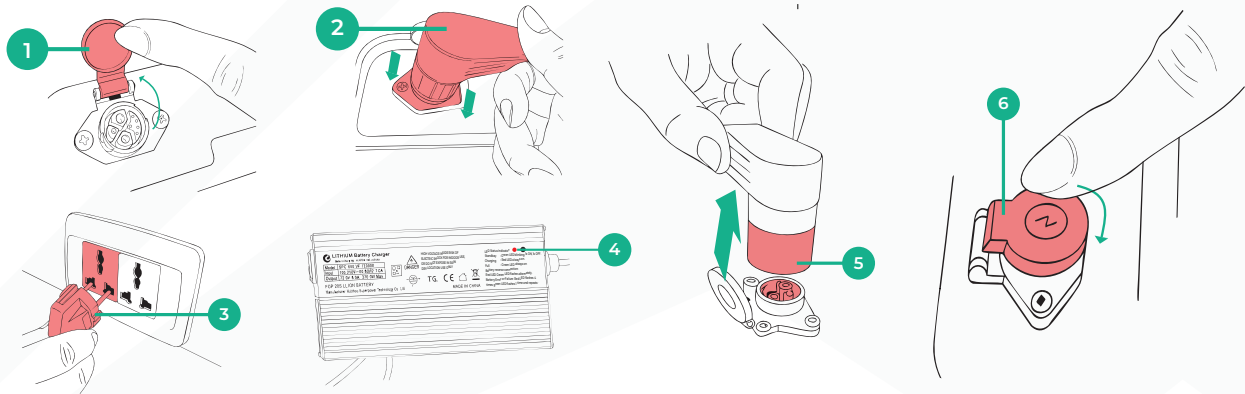

Safety Precautions

- If the vehicle is not used for more than one week, charge the battery at least once a month and store it at its optimal capacity.
- **Always** use and store the battery in the recommended environment to maintain its normal lifespan.
- During regular use, charge the battery in a timely manner, ideally when the battery level falls to around 20%, to extend battery life.
- **Do not** charge the battery in environments below 0°C.
- Use only compliant and approved chargers. Using non-compliant chargers may cause battery leakage, overheating, smoking, fire, or explosion.
- **High Voltage - Do not Disassemble.** Unauthorized disassembly may result in electric shock, leakage, overheating, fire, explosion, or other serious hazards.
- **Do not** pierce, drop, or apply strong pressure to the battery. **Avoid** contact with sharp objects to prevent damage, leakage, overheating, fire, or explosion.
- Charge only in a well-ventilated area with adequate heat dissipation. **Do not** charge the battery in enclosed indoor spaces.

CHARGING GUIDE

SUPER CHARGE (FAST CHARGING STATION)

1. This section explains how to safely charge the Wedison Athena using a Super Charging station (up to 10 kW). Follow the procedure carefully and always use certified charging equipment.
8. Remove the charging gun and return it to the station holder.
9. Close the charging port cover securely.

Preparation Before Super Charging

1. Park the motorcycle on a flat, stable surface.
2. Switch the ignition to OFF and confirm the gear is set to Neutral/Parking Mode (P).
3. Ensure the side stand or center stand is properly engaged.
4. Use only the official Wedison Super Charge Charging Station.
5. Inspect the charging gun and connector to ensure they are clean and free from damage.

A. Super Charging Procedure

1. Open the super charging port cover.
2. Take the charging gun from the station.
3. Insert the gun firmly into the Super Charging port on the motorcycle until it locks in place.
4. Tap your charging card against the charging station display.
5. Make sure the charging indicator light on the Super Charge Station is illuminated to green.
6. Start charging.
7. To stop charging, press the STOP button on the station screen or via the app.

Safety Precautions ⚠

- Use only official Super Charging stations compatible with Wedison vehicles.
- **Do not** charge if the connector or gun is damaged.
- Keep the charging area clear of **children, pets, and flammable materials.**
- **Do not** ride or move the motorcycle during charging.
- **Avoid** charging immediately after long rides; allow the battery to cool first.
- **Stop charging immediately** if smoke, heat, or abnormal smell is detected.



CHARGING GUIDE SUPER CHARGE (FAST CHARGING STATION)

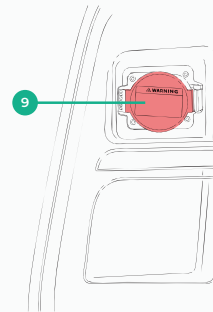
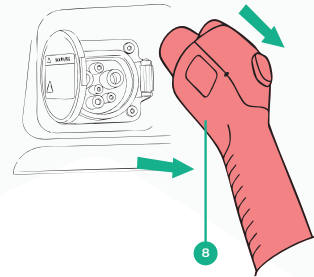
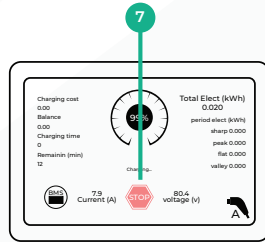
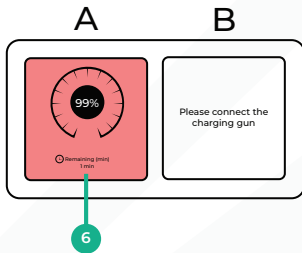
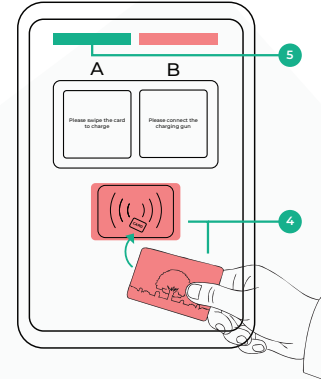
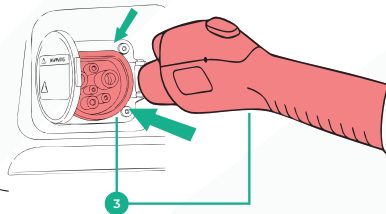
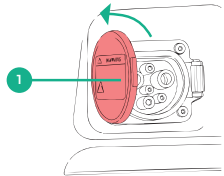

MAINTENANCE & SERVICE SCHEDULE

Regular maintenance is essential to ensure the safety, reliability, and durability of your Wedison Athena. Follow the schedule below and always use an authorized Wedison Service Center for inspections and repairs.

A. Maintenance Checklist (Before each Ride):

- Check tire pressure and tread condition.
- Test front and rear brakes.
- Verify battery charge level.
- Inspect lights, indicators, and horn.
- Ensure side stand and center stand function properly.

B. Periodic Service Schedule

Interval	Inspection / Service Item
Every 500 km	Check tire pressure, lights, horn, brake function.
Every 1,000 km	Inspect brake pads, brake fluid level, and throttle response.
Every 3,000 km	Check suspension, wheel alignment, battery health.
Every 6,000 km	Inspect chassis bolts, electrical wiring, and charging port.
Every 12,000 km	Full service: brakes, suspension, battery diagnostic, motor & controller inspection.
Annually	Complete vehicle inspection at Wedison Service Center.

C. Battery Care

- Do not leave the battery completely discharged for extended periods.
- Recharge at least once every 30 days when not in use.
- Store the battery in a cool, dry place (15–25°C recommended).

D. Safety Precautions ⚠

- Only use original Wedison parts.
- Do not attempt to repair high-voltage components yourself.
- Always have complex repairs performed by an authorized Wedison Service Center.



The Wedison Athena is covered by a limited warranty provided by PT. Wedison Green Energy. This warranty ensures that your motorcycle is free from defects in material or workmanship under normal use and maintenance.

A. Warranty Coverage

- **Motorcycle (Vehicle Body & Components):** 2 years from the date of purchase.
- **Battery Lithium Ion (LFP):** 3 years from the date of purchase.
- **Charger Unit & Charging Port:** 1 year from the date of purchase.
- **Free Services based on mileage :** 1.000 km, 5.000 km, 10.000 km intervals.

B. Exclusions

The warranty does not cover:

- Normal wear and tear (brake pads, tires, bulbs, fuses, etc.).
- Damage caused by misuse, negligence, accidents, or modification.
- Improper maintenance or use of non-Wedison spare parts.
- Damage caused by overloading, racing, or off-road use.
- Charging with unauthorized equipment or in unsafe conditions.

C. Owner's Responsibility

- Perform regular maintenance as outlined in this manual.
- Keep accurate service records in the Service Record Table.
- Use only authorized Wedison Service Centers for inspection and repair.
- Follow all safety instructions and charging procedures.

E. How To Claim Warranty

- Come to the dealer or official **WEDISON** service center.
- Explain the complaint felt about the spare part.
- The dealer will diagnose and inform about repair or replacement of the Spare Part.
- Then, the Warranty Claim submission, including the Free Service that you do will be recorded in the system managed by the dealer or **WEDISON**. That way, every Warranty Claim and Free Service history will be recorded and recorded properly digitally.

F. Important Notes ⚠

- Warranty service is valid only at authorized Wedison dealers and service centers.
- Unauthorized repair or modification voids the warranty.
- Transportation costs to and from the service center are the responsibility of the owner.

FREQUENTLY ASKED QUESTION (F.A.Q) & TROUBLESHOOTING

1. Battery

- What is the battery warranty? → **Wedison battery is covered by a 3 year warranty.**
- How long does it take to fully charge the battery? → **Super Charge: 10%–80% in 15 mins; Regular: 4–6 hrs.**
- What type of battery do you use? → **Lithium-ion Battery (LFP).**
- How many types of battery do you sell? → **2 variations for select models.**
- Where is the battery from? → **Proprietary battery, developed in-house with international partners.**

2. Warranty

- How long is the standard vehicle warranty? → **3 years or 30,000 km.**
- Does warranty cover battery? → **Yes, 3 years.**
- What is excluded from warranty? → **Wear & tear parts (brake pads, tires, bulbs, etc.).**
- Is warranty transferable? → **Yes, if ownership transfer is registered with Wedison.**
- How to claim warranty? → **Visit authorized Wedison service center with service booklet.**

3. Regular Charge

What is the regular charging time? → **4–6 hours.**

Can I use other chargers? → **No, only official Wedison charger.**

What voltage is required? → **220V household socket.**

Can I charge outdoors? → **Yes, but avoid direct rain exposure.**

Does overcharging affect the battery? → **No, system has auto cut-off.**

B. Troubleshooting Guide

Problem - Possible Cause - Solution

- **Motorcycle will not start**
 - Battery is empty, Side stand engaged, System not in Neutral/Parking Mode (P)
 - Recharge the battery, Fold side stand, Set gear to Neutral/Parking Mode (P)
- **Sudden loss of power while riding**
 - Low battery charge, Overheating protection activated
 - Recharge battery, Allow system to cool before restarting
- **Charging does not start**
 - Loose connection, Damaged charger or cable
 - Reconnect charger properly, Replace with official Wedison charger
- **Range is significantly reduced**
 - Riding in Gear 2 frequently, Old or worn battery, Tire pressure too low
 - Use Gear 1 for efficiency, Check battery health, Inflate tires to recommended pressure
- **Warning light stays on**
 - Electrical system fault, Sensor malfunction
 - Do not ride, Contact authorized Wedison Service Center







Athena

**BUKU PANDUAN PENGGUNA WEDISON
BAHASA INDONESIA**

WEDISON USER MANUAL

Table of Content

Wedison User Manual - English		
1	Intro	1
2	Safety Instructions	2
3	Component Overview	4
4	Indicator Codes	8
5	Riding Modes	9
6	Operating Guide	10
7	Riding Instructions	13
8	Charging Guide (Regular & Super Charging)	14
9	Maintenance & Service Schedule	18
10	Warranty & Claim Terms	19
11	FAQ & Troubleshooting	20
Buku Panduan Pengguna Wedison - Bahasa Indonesia		
12	Pendahuluan	24
13	Petunjuk Keselamatan	25
14	Gambaran Umum Komponen	27
15	Indikator Panel	32
16	Mode Berkendara	33
17	Panduan Pengoperasian	34
18	Instruksi Berkendara	37
19	Pengisian Daya (Regular & Super Charge)	38
20	Perawatan & Jadwal Servis	42
21	Syarat Garansi & Klaim	43
22	FAQ & Pemecahan Masalah	44

BUKU PANDUAN PENGGUNA

Selamat atas kepemilikan Wedison Athena, motor listrik bergaya classic sporty dengan tenaga masa kini. Dengan desain yang tak lekang oleh waktu dipadukan dengan performa handal, Athena menghadirkan pengalaman berkendara yang memadukan gaya, kenyamanan, dan masa depan mobilitas.

Buku panduan ini berisi semua informasi penting yang perlu Anda ketahui untuk mengoperasikan, merawat, dan menjaga keselamatan saat menggunakan motor ini.

Bacalah buku panduan ini dengan seksama sebelum mulai berkendara. Dengan memahami cara penggunaan yang benar, Anda dapat memastikan motor selalu dalam kondisi optimal, aman digunakan, dan memiliki umur pemakaian yang lebih panjang.

Hormat Kami,



PETUNJUK KESELAMATAN KESELAMATAN PENGENDARA & BERKENDARA

A. Sebelum berkendara, pastikan untuk:

- Selalu gunakan helm **Berstandar SNI** dan perlengkapan pelindung seperti jaket, sarung tangan, dan sepatu.
- Periksa kondisi motor sebelum setiap perjalanan: rem, lampu, ban, dan indikator baterai.
- Pastikan baterai terpasang dengan benar dan penutupnya terkunci rapat.
- **Jangan** berkendara saat merasa lelah, sakit, atau di bawah pengaruh alkohol maupun obat-obatan.

B. Saat Berkendara, pastikan untuk:

- Selalu patuhi aturan lalu lintas dan rambu jalan.
- **Jangan** melebihi batas kecepatan atau melakukan manuver berbahaya.
- Jaga jarak aman setidaknya 3 detik dari kendaraan di depan.
- Hindari akselerasi mendadak atau pengereman keras, terutama di jalan licin.
- **Jangan** menggunakan ponsel, gadget, atau headphone saat berkendara.
- Selalu nyalakan lampu depan saat hujan, berkabut, atau berkendara di malam hari.
- Hindari melewati jalan tergenang air lebih dari 10 cm karena dapat merusak komponen listrik.
- **Jangan** membawa penumpang lebih dari jumlah yang diizinkan.
- **Jangan** memodifikasi suspensi, sistem pengereman, atau sistem kelistrikan tanpa izin resmi dari Wedison.

C. Kondisi Jalan & Lingkungan

- **Hindari** jalan yang rusak parah, berbatu tajam, atau tidak rata karena dapat membahayakan pengendara dan merusak motor
- **Jangan** berkendara di area dengan sirkulasi udara yang buruk (misalnya basement tertutup) dalam waktu lama.
- **Berhati-hatilah** saat melewati jalan menanjak atau menurun yang curam, terutama jika belum berpengalaman.
- Waspadai kondisi hujan deras, angin kencang, atau kabut tebal, segera cari tempat aman untuk berhenti.

D. Interaksi dengan Kendaraan Lain

- Gunakan klakson seperlunya, jangan berlebihan.
- **Selalu** beri isyarat dengan lampu sein atau tangan berbelok.
- **Jangan** menyalip dari sisi kiri kecuali dalam kondisi aman dan diizinkan.
- **Hindari** mengikuti kendaraan besar (bus, truk) terlalu dekat karena memiliki area blind spot.

E. Berkendara di Malam Hari

- Gunakan lampu utama dengan sorot dekat (**low beam**) agar tidak menyilaukan pengendara lain.
- Pakailah pakaian dengan strip reflektif atau warna cerah agar lebih terlihat.
- Pastikan lampu depan, lampu belakang, dan lampu sein berfungsi dengan baik sebelum berangkat.

PETUNJUK KESELAMATAN KEAMANAN BATERAI DAN PENGISIAN DAYA

A. Keselamatan Umum Baterai

- Gunakan hanya baterai asli yang sudah **tersertifikasi oleh Wedison**.
- **Jangan** membongkar, memodifikasi, atau mencoba memperbaiki baterai sendiri.
- **Jauhkan** baterai dari api, air, dan paparan sinar matahari langsung.
- **Jangan** mengekspos baterai pada suhu di atas 45°C atau di bawah 0°C.
- Jika casing baterai terlihat **berubah bentuk, bocor, atau mengeluarkan bau tidak biasa**, segera hentikan pemakaian.

B. Tindakan Pencegahan Saat Mengisi Daya

- **Selalu** gunakan charger resmi Wedison yang disediakan bersama motor.
- Isi baterai di tempat kering dengan sirkulasi udara yang baik, jauh dari bahan yang mudah terbakar.
- **Jangan** mengisi baterai di kamar mandi, dapur, atau dekat benda yang mudah terbakar.
- **Pastikan** port pengisian bersih dan kering sebelum menyambungkan charger.
- **Jangan** menutup charger atau baterai saat sedang mengisi, biarkan ada sirkulasi udara yang cukup.
- **Hindari** penggunaan baterai sampai benar-benar habis; isi ulang saat level baterai mencapai sekitar 20–30%.
- Cabut charger segera setelah baterai terisi penuh.

C. Kondisi Jalan & Lingkungan

- **Jauhkan** anak-anak dan hewan peliharaan dari area pengisian daya.

- **Jangan** memindahkan kendaraan atau mencoba mengendarainya saat sedang mengisi daya.
- Jika Anda melihat panas berlebih, asap, atau bau tidak normal, segera cabut charger dan hubungi layanan Wedison.
- **Jangan** mengisi daya baterai di luar ruangan saat hujan deras, salju, atau kondisi yang sangat lembab.

D. Peringatan Keselamatan

- Jika kendaraan tidak digunakan lebih dari satu minggu, isi daya baterai setidaknya sekali sebulan dan simpan pada kapasitas optimalnya.
- **Selalu** gunakan dan simpan baterai di lingkungan yang direkomendasikan untuk menjaga umur pakai normalnya.
- Saat penggunaan rutin, isi daya baterai tepat waktu, idealnya ketika level baterai turun hingga sekitar 20%, untuk memperpanjang umur baterai.
- **Jangan** mengisi daya baterai di lingkungan dengan suhu di bawah 0°C.
- Gunakan hanya pengisi daya resmi yang sesuai dan disetujui. Penggunaan pengisi daya yang tidak sesuai dapat menyebabkan kebocoran baterai, panas berlebih, asap, kebakaran, atau ledakan.
- **Tegangan Tinggi - Jangan Dibongkar.** Pembongkaran tanpa izin dapat mengakibatkan sengatan listrik, kebocoran, panas berlebih, kebakaran, ledakan, atau bahaya serius lainnya.
- **Jangan** menusuk, menjatuhkan, atau memberi tekanan kuat pada baterai. **Hindari** kontak dengan benda tajam untuk mencegah kerusakan, kebocoran, panas berlebih, kebakaran, atau ledakan.
- Isi daya hanya di area yang memiliki ventilasi baik dengan pembuangan panas yang memadai. **Jangan** mengisi daya baterai di ruang tertutup dalam ruangan.



GAMBARAN UMUM KOMPONEN SISI DEPAN



1. Kaca Spion
2. Setang
3. Rem
4. Lampu Depan
5. Lampu Sein Depan



GAMBARAN UMUM KOMPONEN SISI SAMPING



1. Port Super Charge
2. Jok
3. Lampu Belakang
4. Reflektor Samping
5. Peredam Kejut Ganda
6. Mesin
7. Ban Belakang
8. Standar Tengah
9. Standar Samping
10. Ban Depan
11. Rem Cakram Depan



GAMBARAN UMUM KOMPONEN SISI BELAKANG



1. Lubang Kunci
2. Port USB
3. Lampu Sein Belakang
4. Reflektor Belakang



GAMBARAN UMUM KOMPONEN LAYAR SPEEDOMETER



READY

Indikator Mode

0.0 km/h

Indikator Kecepatan

ECO

Indikator Mode ECO

Normal

Indikator Mode Normal



Tingkat Baterai

0.0 KM

Total Jarak Tempuh



GAMBARAN UMUM KOMPONEN BAGIAN INSTRUMEN SETANG

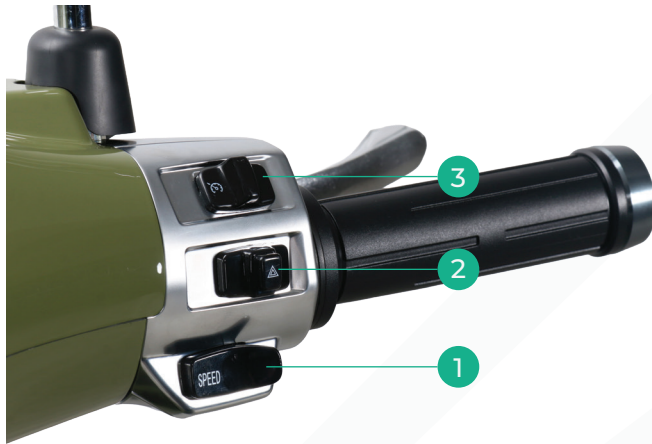

Setang Kanan





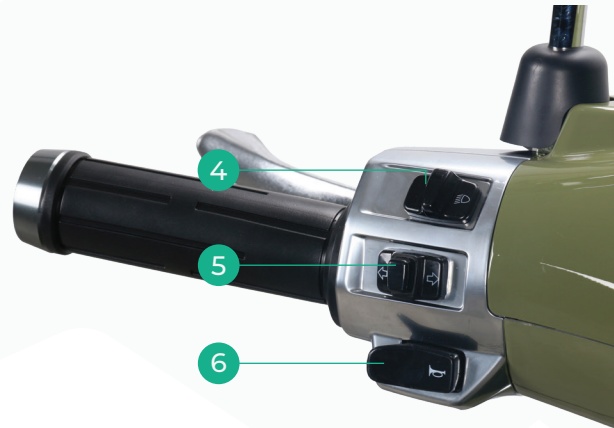

1. Tombol Pergantian Gigi
2. Tombol Lampu Hazard
3. Tombol Lampu Depan

Setang Kiri

4. Tombol Pengatur Jarak Lampu
5. Tombol Lampu Sein
6. Tombol Klakson



INDIKATOR PANEL

READY	Indikator Mode	Menunjukkan mode yang sedang aktif.
 0 Km/h	Indikator Kecepatan	Menampilkan kecepatan yang sedang ditempuh.
GEAR	Indikator Level Gigi	Menampilkan level gigi yang sedang digunakan.
0.0 km	Jarak Tempuh Total	Menampilkan total jarak tempuh perjalanan.
	Indikator Baterai	Menampilkan level baterai motor Anda.
P	Indikator Lampu Sein	Menunjukkan lampu sein aktif, siap digunakan untuk berbelok.
	Indikator Sorot Lampu Depan	Menunjukkan mode sorot lampu depan yang sedang digunakan.
	Status Pengisian Daya	Ditampilkan saat motor sedang dalam pengisian daya.
	Indikator Pengereman	Ditampilkan saat Anda sedang menggunakan rem.
	Peringatan Sistem ECU	Ditampilkan untuk memberi tahu pengendara bahwa sistem ECU rusak atau perlu diperbaiki.
	Peringatan Kerusakan Mesin	Ditampilkan untuk memberi tahu pengendara bahwa bagian mesin rusak atau perlu diperbaiki.



Wedison Athena dilengkapi dengan sistem transmisi dua gigi bergaya konvensional, ditambah dengan posisi Netral (Mode Parkir). Hal ini memungkinkan pengendara menyesuaikan performa dengan kondisi jalan yang berbeda sambil tetap menjaga kontrol yang halus, mirip dengan sepeda motor tradisional.

A. Level Gigi

- Gigi 1:
 - Digunakan saat mulai dari keadaan diam, menanjak, atau berkendara di lalu lintas padat.
 - Memberikan respon gas yang lebih halus pada kecepatan rendah.
- Gigi 2:
 - Digunakan untuk berkendara santai (*cruising*) dan kecepatan lebih tinggi.
 - Memberikan akselerasi lebih kuat dan efisiensi yang lebih baik di jalan terbuka.
- Mode Parkir (P):
 - Digunakan saat parkir atau ketika motor dalam keadaan diam.
 - Daya tidak diteruskan ke roda.

B. Instruksi Pergantian Gigi

- Selalu jaga bukaan gas tetap stabil saat mengganti gigi.
- Pindah ke **Gigi 2** saat kendaraan mencapai kecepatan menengah atau membutuhkan tenaga lebih.

- Turun ke **Gigi 1** saat melambat, menanjak, atau membutuhkan kontrol lebih.
- Pindah ke posisi Netral (Mode Parkir) hanya saat kendaraan benar-benar berhenti.

C. Tindakan Keselamatan

- **Jangan** menarik gas secara mendadak saat mengganti gigi.
- **Selalu** pastikan indikator gigi di dashboard sebelum berakselerasi.
- Pindahkan ke posisi Netral sebelum parkir atau meninggalkan motor tanpa pengawasan.

D. Perhatian pada Indikator Dashboard

- **Selalu** periksa indikator gigi di panel instrumen sebelum berakselerasi.
- Pastikan huruf “P” (**Mode Parkir**) muncul saat memarkir motor atau menyalakannya tanpa niat untuk berkendara.
- **Jangan** mengabaikan lampu peringatan atau indikator error saat mengoperasikan gigi.

PANDUAN PENGOPERASIAN PERSIAPAN SEBELUM MENYALAKAN

Bagian ini menjelaskan pengoperasian dasar Wedison Athena, mulai dari menyalakan motor, berkendara normal, hingga memarkir. Selalu ikuti langkah-langkah dengan hati-hati untuk memastikan penggunaan yang aman.

Persiapan Sebelum Menyalakan

1. Masukkan kunci ke lubang kontak
2. Lalu putar kunci ke posisi "🔓", hingga kunci jok terbuka.
3. Angkat jok.
4. Geser tuas pada *Pemutus Arus (Circuit Breaker)* yang berada dibawah jok sampai berada diposisi "ON".

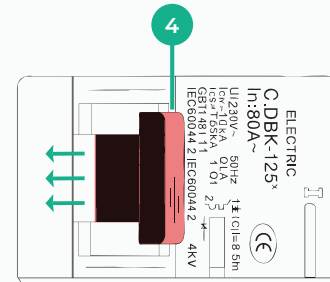
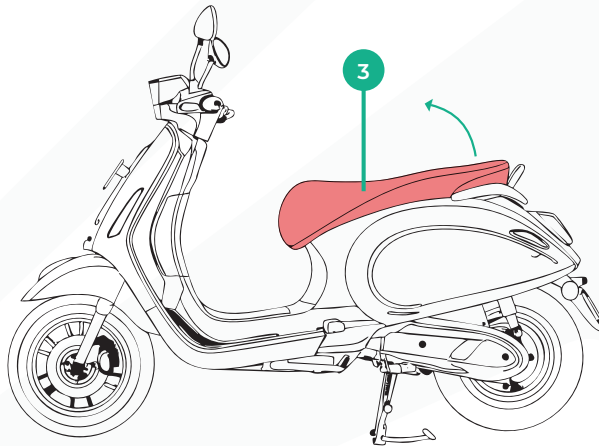
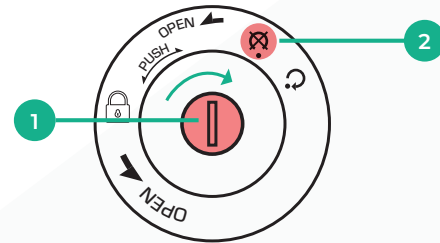

PANDUAN PENGOPERASIAN PROSEDUR MENYALAKAN MOTOR

Prosedur Menyalakan Motor:

1. Masukkan kunci ke lubang kontak dan putar ke posisi “↻”.
2. Pastikan standar samping terlipat dan motor dalam posisi tegak.
3. Periksa indikator di dashboard: level baterai, gigi/mode, dan lampu peringatan.
4. Tekan dan tahan salah satu tuas rem sampai “P” menghilang.
5. Pastikan lampu indikator Normal menyala. Pilih gigi yang diinginkan (Gigi 1 untuk mulai jalan).
6. Putar gas perlahan untuk mulai bergerak maju.

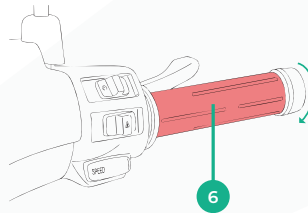
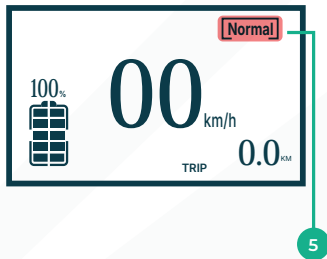
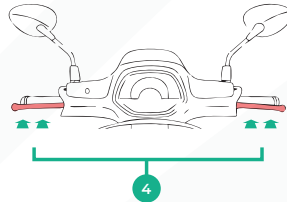
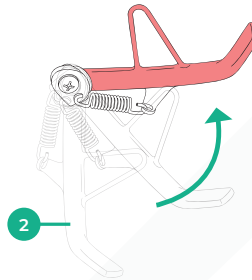
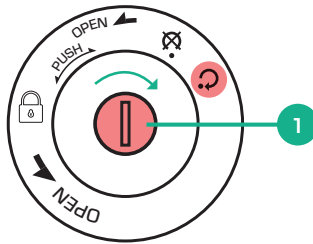

PANDUAN PENGOPERASIAN

A. Catatan Penting ⚠

1. Motor **tidak akan** berfungsi jika standar samping masih terbuka.
2. **Selalu** pastikan indikator gigi **sebelum** menarik gas.
3. **Jangan** menarik gas secara mendadak segera setelah motor dinyalakan untuk menghindari gerakan yang tidak diinginkan.
4. Jika ada lampu peringatan yang tetap menyala, **jangan** digunakan untuk berkendara. Hubungi Bengkel Resmi Wedison.



A. Sebelum Berkendara

- Periksa tekanan ban, rem, lampu, klakson, dan spion.
- Pastikan level baterai cukup untuk perjalanan yang direncanakan.
- Pastikan standar samping terlipat dan motor dalam posisi tegak.
- Pastikan indikator gigi berada di **Gigi 1** sebelum mulai jalan.

B. Mulai Berkendara

- Tahan salah satu tuas rem.
- Putar gas perlahan untuk berakselerasi dengan mulus.
- Pegang setang dengan kedua tangan dan letakkan kedua kaki di pijakan kaki.
- Lepaskan rem secara bertahap sambil menambah gas untuk mulai bergerak maju.

C. Berkendara di Kecepatan Rendah dan Sedang

- Gunakan **Gigi 1** untuk jalan pelan, lalu lintas padat, atau saat menanjak.
- Pindahkan ke **Gigi 2** ketika motor sudah mencapai kecepatan stabil untuk cruising.
- Jaga jarak aman dengan kendaraan lain.

D. Pengereman

- Tutup gas secara perlahan.
- Gunakan kedua rem (depan dan belakang) secara bersamaan.

- **Hindari** pengereman mendadak atau keras untuk mencegah selip.
- **Turun ke Gigi 1** jika melambat secara signifikan atau mendekati berhenti.

E. Berhenti

- Hentikan motor sepenuhnya dengan menggunakan kedua rem.
- Pindahkan tuas gigi ke **Netral / Mode Parkir (P)**.
- Tetap tahan rem sampai motor dalam keadaan stabil.

F. Tindakan Keselamatan ⚠

- **Jangan** berakselerasi secara tiba-tiba.
- **Selalu** nyalakan sein sebelum berbelok atau pindah jalur.
- **Kurangi kecepatan** saat berkendara di jalan basah, berpasir, atau tidak rata.
- **Jangan** membawa penumpang melebihi kapasitas yang ditentukan motor.
- **Hindari** gangguan seperti menggunakan ponsel saat berkendara.

PANDUAN PENGISIAN DAYA REGULAR CHARGE (PENGISIAN DI RUMAH)

Bagian ini menjelaskan cara mengisi daya baterai Wedison Athena dengan metode standar. Selalu ikuti langkah-langkah secara berurutan untuk memastikan pengisian daya yang aman dan efisien.

Persiapan Sebelum Mengisi Daya

- Parkirkan motor di permukaan datar dan stabil.
- Putar kontak ke posisi OFF dan pastikan gigi berada di posisi Netral / Mode Parkir (P).
- Pastikan standar samping atau standar tengah digunakan dengan benar.
- Gunakan hanya charger resmi Wedison yang disertakan bersama motor.
- Periksa port pengisian dan kabel agar bersih, kering, dan tidak rusak.

A. Prosedur Pengisian

1. Buka penutup port pengisian.
2. Masukkan konektor charger dengan kuat ke port pengisian motor.
3. Colokkan charger ke stop kontak listrik AC standar.
4. Pastikan lampu indikator pengisian menyala.
5. Setelah pengisian selesai, cabut kabel daya AC terlebih dahulu, lalu lepaskan charger dari motor.
6. Tutup kembali port pengisian dengan rapat.

Light Indicator :

- **Red** = Charging in Progress
- **Green** = Charging Completed

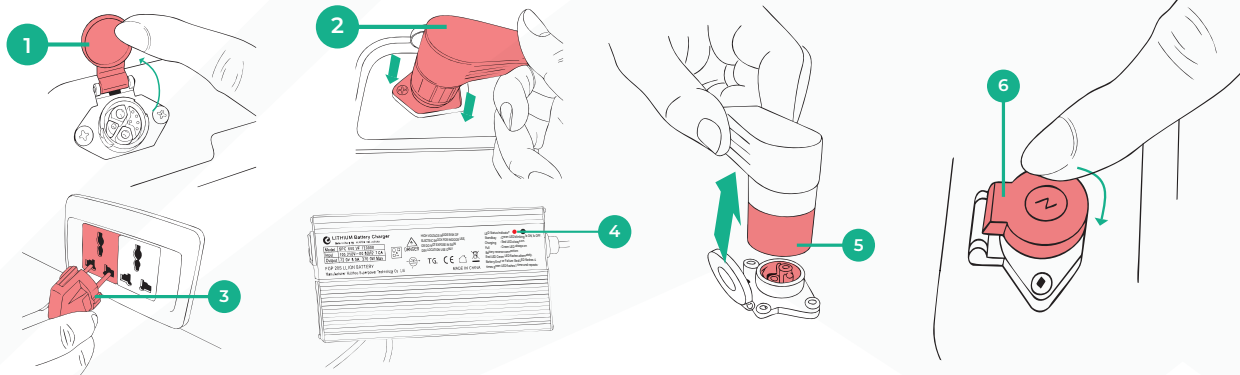

Tindakan Keselamatan ⚠

- Jika kendaraan tidak digunakan lebih dari satu minggu, isi daya baterai minimal sebulan sekali dan simpan pada kapasitas optimal.
- **Selalu** gunakan dan simpan baterai di lingkungan yang direkomendasikan untuk menjaga umur pakai.
- Saat penggunaan normal, lakukan pengisian tepat waktu idealnya ketika kapasitas baterai turun hingga sekitar **20%**, untuk memperpanjang umur baterai.
- **Jangan** mengisi daya baterai di lingkungan dengan suhu di bawah **0°C**.
- Gunakan hanya charger resmi dan sesuai standar. Charger non-kompatibel dapat menyebabkan kebocoran, panas berlebih, asap, kebakaran, atau ledakan.
- **Tegangan tinggi - jangan membongkar baterai.** Membongkar tanpa izin dapat menyebabkan sengatan listrik, kebocoran, panas berlebih, kebakaran, ledakan, atau bahaya serius lainnya.
- **Jangan** menusuk, menjatuhkan, atau memberi tekanan kuat pada baterai. **Hindari** kontak dengan benda tajam agar terhindar dari kerusakan, kebocoran, panas berlebih, kebakaran, atau ledakan.
- Isi daya hanya di area yang berventilasi baik dengan pembuangan panas yang memadai. **Jangan** mengisi daya di ruang tertutup tanpa sirkulasi udara.

PANDUAN PENGISIAN DAYA SUPER CHARGE (PENGISIAN CEPAT)

1. Bagian ini menjelaskan cara mengisi daya baterai Wedison Athena dengan menggunakan stasiun Super Charging (hingga 10 kW). Ikuti prosedur dengan hati-hati dan selalu gunakan peralatan pengisian yang tersertifikasi.
8. Lepaskan gun charger dan kembalikan ke dudukannya di stasiun.
9. Tutup kembali port pengisian dengan rapat.

Persiapan Sebelum Super Charging

- Parkirkan motor di permukaan datar dan stabil.
- Putar kontak ke posisi OFF dan pastikan gigi berada di Netral/Mode Parkir (P).
- Pastikan standar samping atau standar tengah digunakan dengan benar.
- Gunakan hanya Stasiun Pengisian Super Charge resmi Wedison.
- Periksa kondisi gun charger dan konektor agar bersih serta bebas dari kerusakan.

A. Prosedur Super Charging

1. Buka penutup port super charging.
2. Ambil gun charger dari stasiun.
3. Masukkan gun dengan kuat ke port Super Charging pada motor hingga terkunci.
4. Tempelkan kartu pengisian ke layar stasiun pengisian.
5. Pastikan lampu indikator pengisian pada Stasiun Super Charge menyala hijau.
6. Mulai proses pengisian.
7. Untuk menghentikan pengisian, tekan tombol STOP di layar stasiun atau melalui aplikasi.

Tindakan Keselamatan ⚠

- Gunakan hanya stasiun Super Charging resmi yang kompatibel dengan kendaraan Wedison.
- **Jangan** mengisi daya jika konektor atau gun charger rusak.
- Jaga area pengisian tetap bebas dari anak-anak, hewan peliharaan, dan bahan yang mudah terbakar.
- **Jangan** mengendarai atau memindahkan motor saat proses pengisian.
- **Hindari** mengisi daya langsung setelah perjalanan panjang, biarkan baterai dingin terlebih dahulu.
- **Hentikan segera** pengisian jika muncul asap, panas berlebih, atau bau yang tidak normal.

CHARGING GUIDE SUPER CHARGE (FAST CHARGING STATION)

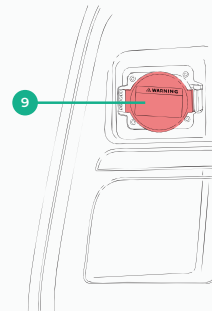
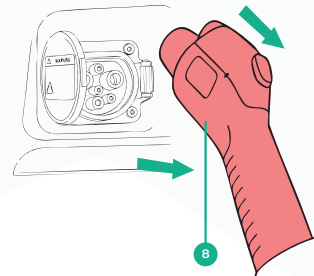
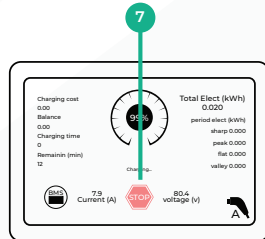
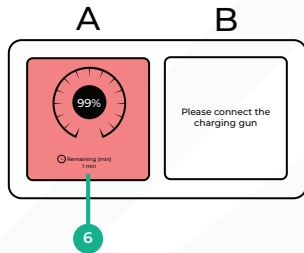
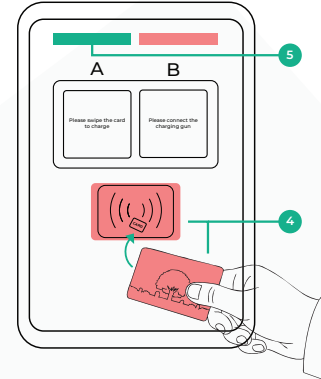
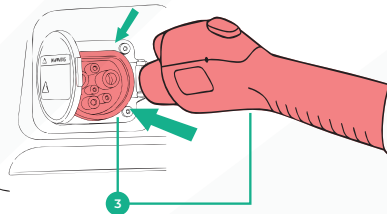
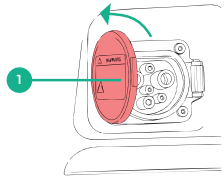

MAINTENANCE & SERVICE SCHEDULE

Perawatan rutin sangat penting untuk memastikan keselamatan, keandalan, dan daya tahan Wedison Athena anda. Ikuti jadwal di bawah ini dan selalu gunakan Bengkel Resmi Wedison untuk inspeksi dan perbaikan.

A. Daftar Perawatan (Sebelum Setiap Perjalanan)

- Periksa tekanan dan kondisi tapak ban.
- Uji rem depan dan belakang.
- Pastikan level daya baterai mencukupi.
- Periksa lampu, indikator, dan klakson.
- Pastikan standar samping dan standar tengah berfungsi dengan baik.

B. Periodic Service Schedule

Jeda	Pemeriksaan / Perbaikan Komponen
Setiap 500 km	Periksa tekanan ban, lampu, klakson, dan fungsi rem.
Setiap 1,000 km	Periksa kampas rem, level cairan rem, dan respon gas.
Setiap 3,000 km	Periksa suspensi, keselarasan roda, dan kesehatan baterai.
Setiap 6,000 km	Periksa baut rangka, kabel kelistrikan, dan port pengisian.
Setiap 12,000 km	Servis lengkap: rem, suspensi, diagnostik baterai, pemeriksaan motor & sistem pengendali.
Tahunan	Pemeriksaan kendaraan lengkap di Bengkel Resmi Wedison.

C. Perawatan Baterai

- Jangan biarkan baterai benar-benar kosong dalam waktu lama.
- Isi ulang setidaknya sekali setiap 30 hari jika motor tidak digunakan.
- Simpan baterai di tempat sejuk dan kering (suhu yang dianjurkan 15–25°C).

D. Tindakan Keselamatan ⚠

- Gunakan hanya suku cadang resmi Wedison.
- Jangan mencoba memperbaiki sendiri komponen bertegangan tinggi.
- Selalu lakukan perbaikan yang kompleks di Bengkel Resmi Wedison.



Wedison Athena dilindungi oleh garansi terbatas yang diberikan oleh PT. Wedison Green Energy. Garansi ini memastikan motor Anda bebas dari cacat material maupun pengerjaan di bawah penggunaan dan perawatan normal.

A. Cakupan Garansi

- Motor (Bodi & Komponen Kendaraan): 2 tahun sejak tanggal pembelian.
- Baterai Lithium Ion (LFP): 3 tahun sejak tanggal pembelian.
- Unit Charger & Port Pengisian: 1 tahun sejak tanggal pembelian.
- Servis Gratis berdasarkan jarak : Dalam jangka 1.000 km, 5.000 km, 10.000 km

B. Pengecualian

Garansi tidak mencakup:

- Keausan normal (kampas rem, ban, bohlam, sekring, dll.).
- Kerusakan akibat penyalahgunaan, kelalaian, kecelakaan, atau modifikasi.
- Perawatan yang tidak sesuai atau penggunaan suku cadang non-Wedison.
- Kerusakan akibat kelebihan beban, balapan, atau penggunaan off-road.
- Pengisian daya dengan peralatan tidak resmi atau di kondisi yang tidak aman.

C. Tanggung Jawab Pemilik

- Lakukan perawatan rutin sesuai panduan di buku ini.
- Catat riwayat servis secara akurat di Tabel Catatan Servis.
- Gunakan hanya **Bengkel Resmi Wedison** untuk pemeriksaan dan perbaikan.
- Ikuti semua petunjuk keselamatan dan prosedur pengisian daya.

E. Cara Klaim Garansi

- Datang ke dealer atau **bengkel resmi Wedison**.
- Jelaskan keluhan yang dirasakan terkait suku cadang.
- Dealer akan mendiagnosis dan memberikan informasi mengenai perbaikan atau penggantian suku cadang.
- Pengajuan klaim garansi, termasuk layanan servis gratis yang Anda lakukan, akan dicatat dalam sistem yang dikelola oleh dealer atau Wedison. Dengan demikian, setiap riwayat klaim garansi dan servis gratis akan terdokumentasi secara digital.

F. Catatan Penting ⚠

- Layanan garansi hanya berlaku di dealer dan bengkel resmi Wedison.
- Perbaikan atau modifikasi tidak resmi akan membatalkan garansi.
- Biaya transportasi ke dan dari bengkel menjadi tanggung jawab pemilik.

PERTANYAAN YANG SERING DIAJUKAN (F.A.Q) & PEMECAHAN MASALAH

Baterai

- Berapa lama garansi baterai? → **Baterai Wedison dilindungi garansi 3 tahun.**
- Berapa lama waktu pengisian penuh baterai? → **Dengan Super Charge: 10%–80% hanya 15 menit; Regular charge: 4–6 jam (tergantung kondisi & kapasitas baterai).**
- Jenis baterai apa yang digunakan? → **Baterai Lithium-ion (LFP).**
- Berapa jenis baterai yang dijual? → **Ada 2 variasi untuk beberapa model.**
- Dari mana asal baterai? → **Baterai proprietary yang dikembangkan in-house, bekerja sama dengan mitra internasional.**

Garansi

- Berapa lama garansi standar kendaraan? → **3 tahun atau 30.000 km.**
- Apakah garansi mencakup baterai? → **Ya, berlaku 3 tahun.**
- Apa yang tidak termasuk garansi? → **Komponen yang aus karena pemakaian (kampas rem, ban, bohlam, dll.).**
- Apakah garansi bisa dipindahtangankan? → **Ya, selama perpindahan kepemilikan terdaftar di Wedison.**
- Bagaimana cara klaim garansi? → **Datang ke bengkel resmi Wedison dengan membawa buku servis.**

3. Regular Charge

- Berapa lama waktu pengisian biasa? → **4–6 jam.**
- Bisakah menggunakan charger lain? → **Tidak bisa, hanya menggunakan charger resmi Wedison.**
- Tegangan berapa yang dibutuhkan? → **220V stopkontak rumah tangga.**
- Apakah bisa isi daya di luar ruangan? → **Bisa, tapi hindari terkena hujan langsung.**

- Apakah overcharge berpengaruh pada baterai? → **Tidak, karena sistem sudah memiliki auto cut-off.**

B. Panduan Pemecahan Masalah

Masalah - Penyebab Kemungkinan - Solusi

- **Motor tidak mau menyala**
- **Baterai habis, standar samping terbuka, sistem tidak di posisi Netral/Mode Parkir (P).**
- **Isi ulang baterai, lipat standar samping, atur gigi ke Netral/Mode Parkir (P).**
- **Tiba-tiba kehilangan tenaga saat berkendara**
- **Baterai lemah, perlindungan panas berlebih aktif.**
- **Isi ulang baterai, biarkan sistem mendingin sebelum menyalakan kembali.**
- **Pengisian daya tidak dimulai**
- **Sambungan longgar, charger atau kabel rusak.**
- **Sambungkan ulang charger dengan benar, ganti dengan charger resmi Wedison.**
- **Jarak tempuh berkurang drastis**
- **Sering menggunakan Gigi 2, baterai tua/aus, tekanan ban terlalu rendah.**
- **Gunakan Gigi 1 untuk efisiensi, periksa kesehatan baterai, pompa ban sesuai tekanan yang dianjurkan.**
- **Lampu peringatan tetap menyala**
- **Kerusakan sistem kelistrikan, sensor bermasalah.**
- **Jangan digunakan untuk berkendara, hubungi Bengkel Resmi Wedison.**



MAINTENANCE RECORD
(TABEL CATATAN PERAWATAN)

No.	Tanggal Service	Kilometer	Jenis Servis	Nama Teknisi	Stempel Dealer
1					
2					
3					
4					
5					
6					
7					
8					
9					
10					
11					
12					
13					
14					
15					
16					
17					

MAINTENANCE RECORD
(TABEL CATATAN PERAWATAN)

No.	Tanggal Service	Kilometer	Jenis Servis	Nama Teknisi	Stempel Dealer
18					
19					
20					
21					
22					
23					
24					
25					
26					
27					
28					
29					
30					

Tanggal Pendaftaran Penjualan :

Informasi Manufaktur	Pabrik Manufaktur		Alamat Produksi	
	Kode Pos		No. Telp.	
Informasi Distributor	Nama Distributor		No Layanan Purnajual	
	Nomor Distributor		Narahubung	
	Alamat Distributor		Alamat Toko	
Informasi Produk	Nama Produk		Manufaktur Baterai	
	Model Kendaraan		Model Baterai Daya	
	Nomor Mobil (Nomor Rangka Mobil)		Manufaktur Pengisi	
			Model Pengisi Daya	
Nomor Motor		Warna Produk		
Informasi Klien	Nama Klien		Tanggal Lahir	
	Alamat		Pekerjaan	<input type="checkbox"/> PNS <input type="checkbox"/> Pegawai Swasta <input type="checkbox"/> Buruh <input type="checkbox"/> Mahasiswa <input type="checkbox"/> : _____
	No. Invoice		Jenis Pembelian	<input type="checkbox"/> Pembelian Pertama <input type="checkbox"/> Pembelian Ulang

The background is a solid teal color with several abstract, overlapping geometric shapes in a darker shade of teal. These shapes are primarily triangles and quadrilaterals, creating a dynamic, layered effect. The shapes are positioned on the left side of the frame, extending towards the center.

WEDISON

Motor Listrik Yang Paling Super Nge-Chargenya!

www.wedison.co